



MEGA SLIM™

T6/T9/T12/T20 PORCELAIN SLAB

2025

2026

CATALOGUE





CONTENTS

- 6 / TIGER
- 8 / STARLIGHT
- 10 / CRYSTAL LACE
- 12 / AMAZZONITE
- 14 / CLIFF WHITE
- 16 / MARMO ANTICO
- 18 / TRAVERTINE WHITE
- 20 / MONET
- 22 / TAJ MAHAL MAX
- 24 / BLUE ROMA
- 26 / CANELA ROMA
- 28 / TAJ MAHAL
- 30 / WHITE BEAUTY
- 32 / LIGHT RED CALACATTA
- 34 / ARABESCATO VIOLA
- 36 / CARAVAGGIO GOLD
- 38 / BRIGHT PRECIOUS
- 40 / CALACATTA VIOLA
- 42 / TIVOLI WHITE VEIN CUT
- 44 / TIVOLI SAND VEIN CUT
- 46 / BLACK DIAMOND
- 48 / CRYSTAL
- 50 / AMBER
- 52 / JADE
- 54 / GEMSTONE
- 56 / MACCHIA ANTICA
- 58 / BALLET
- 60 / INVISIBLE GREY
- 61 / CALACATTA GOLD
- 62 / STATUARIO REALE
- 63 / CALACATTA ORO
- 64 / LILAC
- 65 / SUPER WHITE DOLOMITE
- 66 / STATUARIO SUPERIORE
- 67 / PIERRE BLACK
- 68 / MARQUINA BLACK
- 69 / ARABESCATO
- 70 / CELLINI
- 71 / PALLADIO
- 72 / MAGMA NATURAL
- 73 / MAGMA AVIO
- 73 / MAGMA BLACK & WHITE
- 74 / ABSOLUTE
- 75 / BASALTINA NERO
- 76 / EMOTION EUPHORIA
- 76 / BARDIGLIO
- 77 / STATUARIO EXTRA
- 78 / GRIGIO VENEZIANO
- 79 / PIETRA GRIGIA
- 79 / PIETRA TAUPE
- 80 / INVISIBLE GOLD
- 81 / MACCHIA VECCHIA
- 81 / PACISTA
- 82 / CALACATTA VAGLI
- 83 / CALACATTA EXTRA
- 84 / STATUARIO PREMIUM
- 85 / CALACATTA ULTIMATE
- 86 / VERDE
- 86 / AZUL
- 87 / METRO GREY
- 87 / SUPER BLACK
- 88 / TECHNICAL DETAILS
- 90 / GUIDELINES

Note: Any product information provided is solely indicative and final manufactured product may vary from what is shown. Any given dimension refers to products nominal size, not actual working size. For correct further details please contact us.

When face selection on flowing patterns panels is requested we cannot guarantee that what selected will be all available as product is packed randomly by the manufacturers.

When placing such orders (a pattern selection fee applies), we will require to be given possible alternatives else we will pack these on our discretion to the required quantities. Additionally, continuous veining patterns across sequential panels is subject to the typical tolerance of natural stone products and as such some miss-alignment must be accepted.





TIGER

BOOK MATCH PATTERN

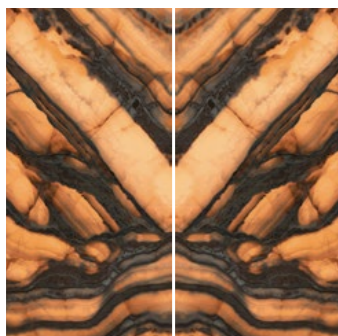

The ALL-LIGHT effect, derived from sophisticated graphic design, reproduces the effect of natural backlighting and gives the surface a luminous radiance appealing. Its elegant, modern appearance is ideal for striking, luxurious interior design projects.

MEGASLIM
T12 PORCELAIN SLAB



DETAILS

size **3200x1600 mm**

thickness **12mm**

finish **All-Light Polished**

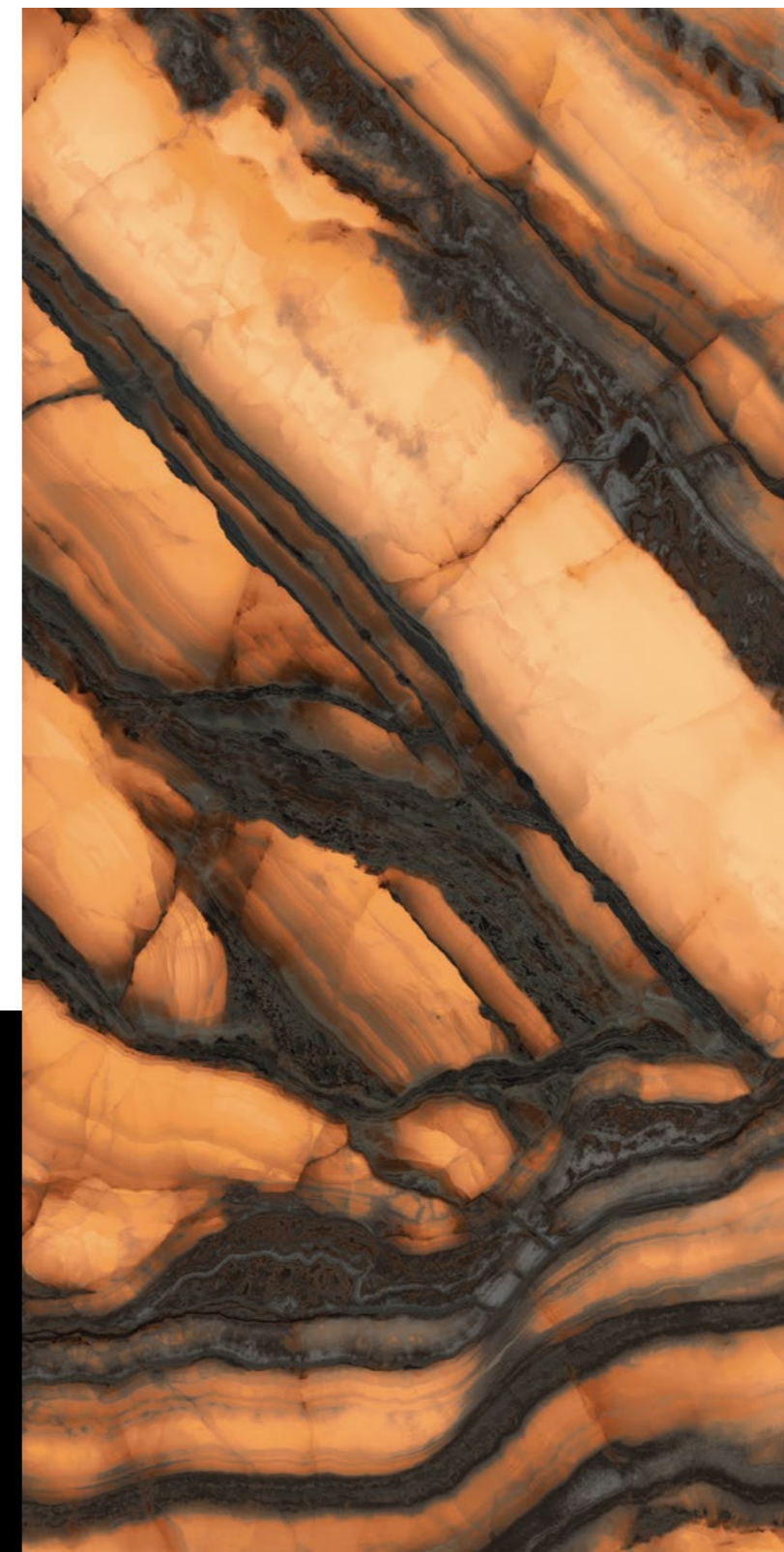



MEGASLIM
T12 PORCELAIN SLAB

MADE IN ITALY

STARLIGHT

BOOK MATCH PATTERN

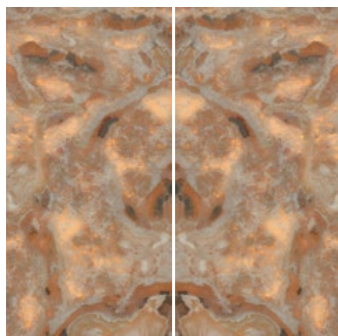

The ALL-LIGHT effect, derived from sophisticated graphic design, reproduces the effect of natural backlighting and gives the surface a luminous radiance appealing. Its elegant, modern appearance is ideal for striking, luxurious interior design projects.

DETAILS

size **3200x1600 mm**

thickness **12mm**

finish **All-Light Polished**

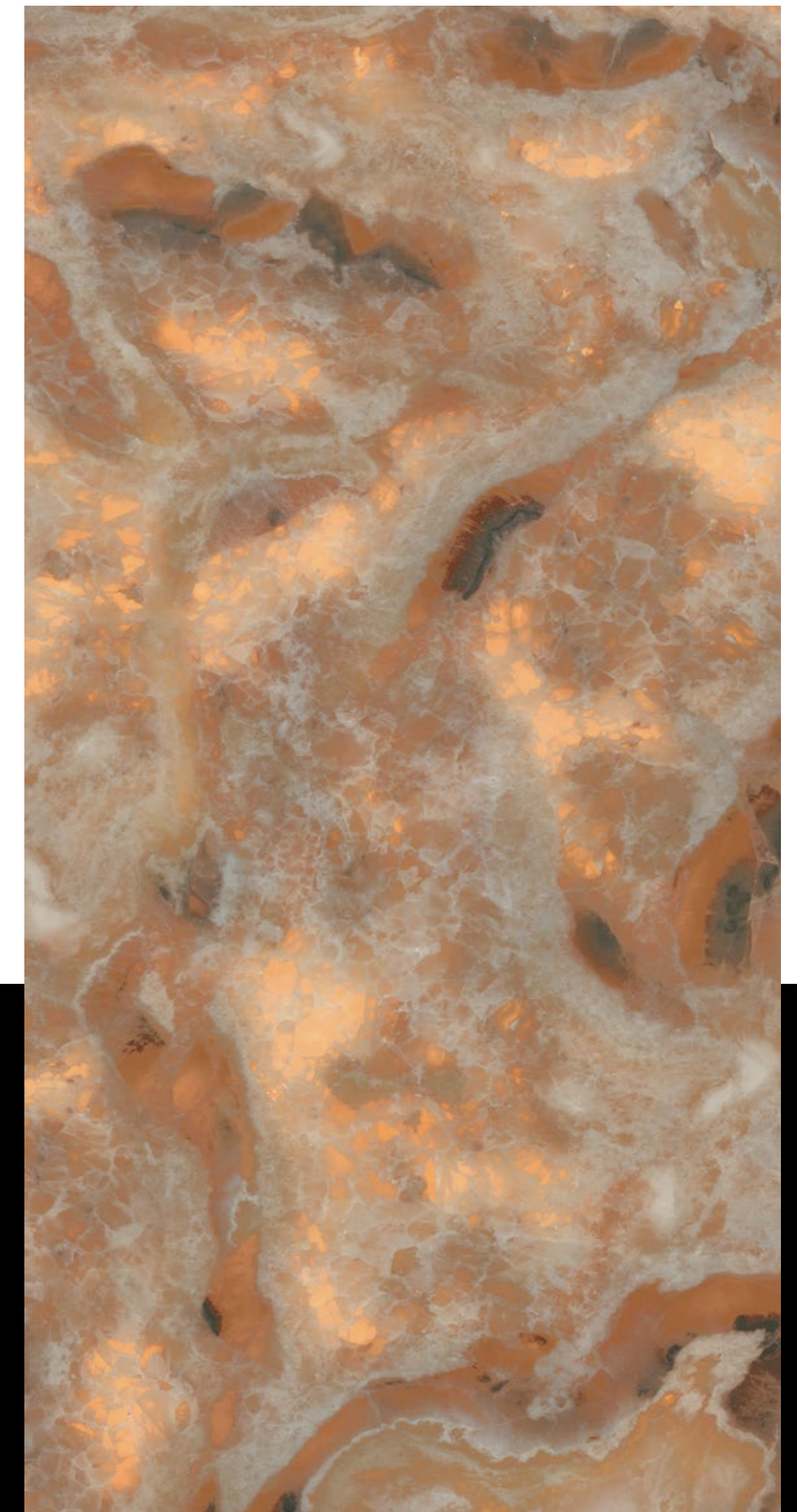



CRYSTAL LACE

BOOK MATCH PATTERN

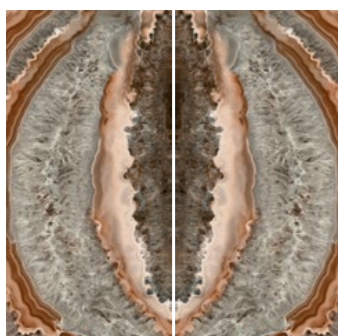

MEGASLIM
T12 PORCELAIN SLAB



MADE IN ITALY

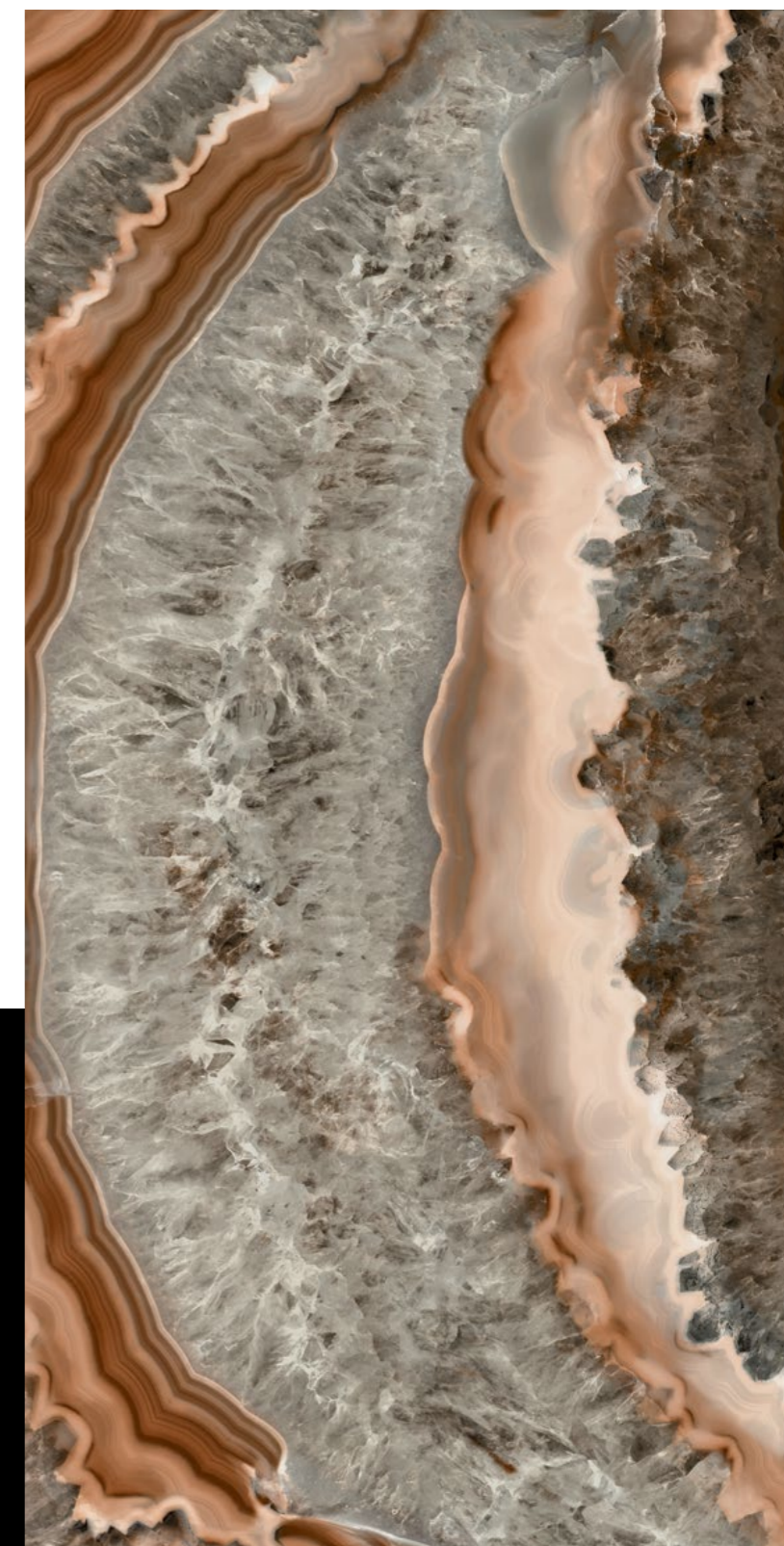

DETAILS

size **3200x1600 mm**

thickness **12mm**

finish **Polished**



MEGASLIM
T12 PORCELAIN SLAB

MADE IN ITALY

AMAZZONITE

BOOK MATCH PATTERN

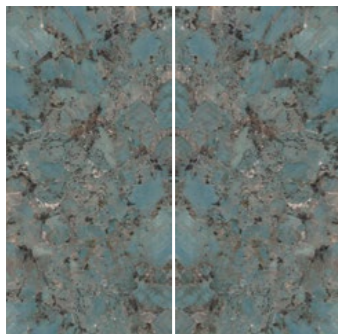

DETAILS

size **3200x1600 mm**

thickness **12mm**

finish **Polished**

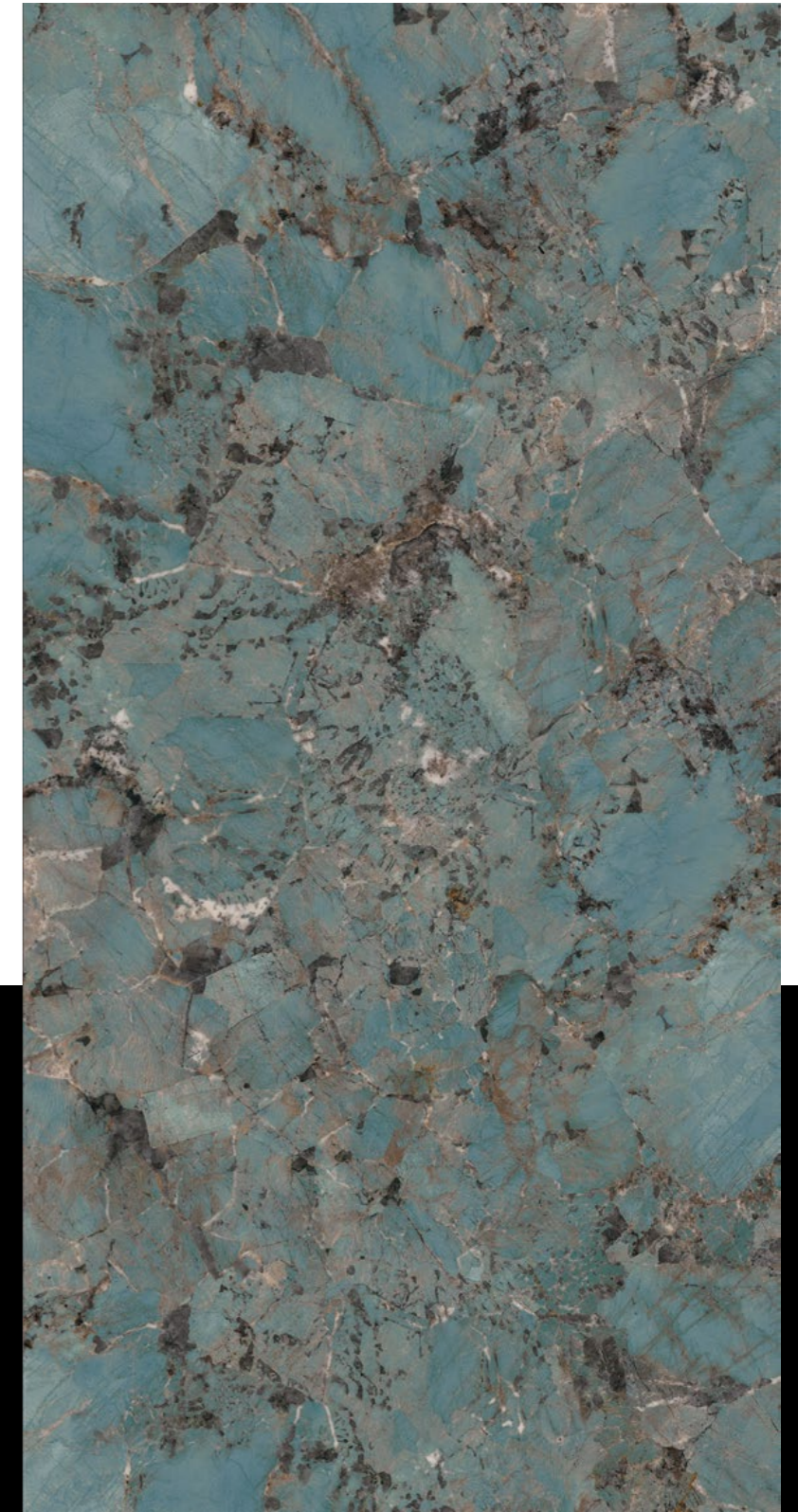



CLIFF WHITE

BOOK MATCH PATTERN

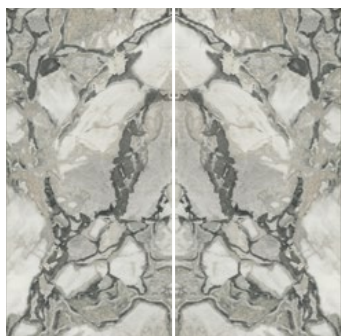

MEGASLIM
T12 PORCELAIN SLAB



MADE IN ITALY

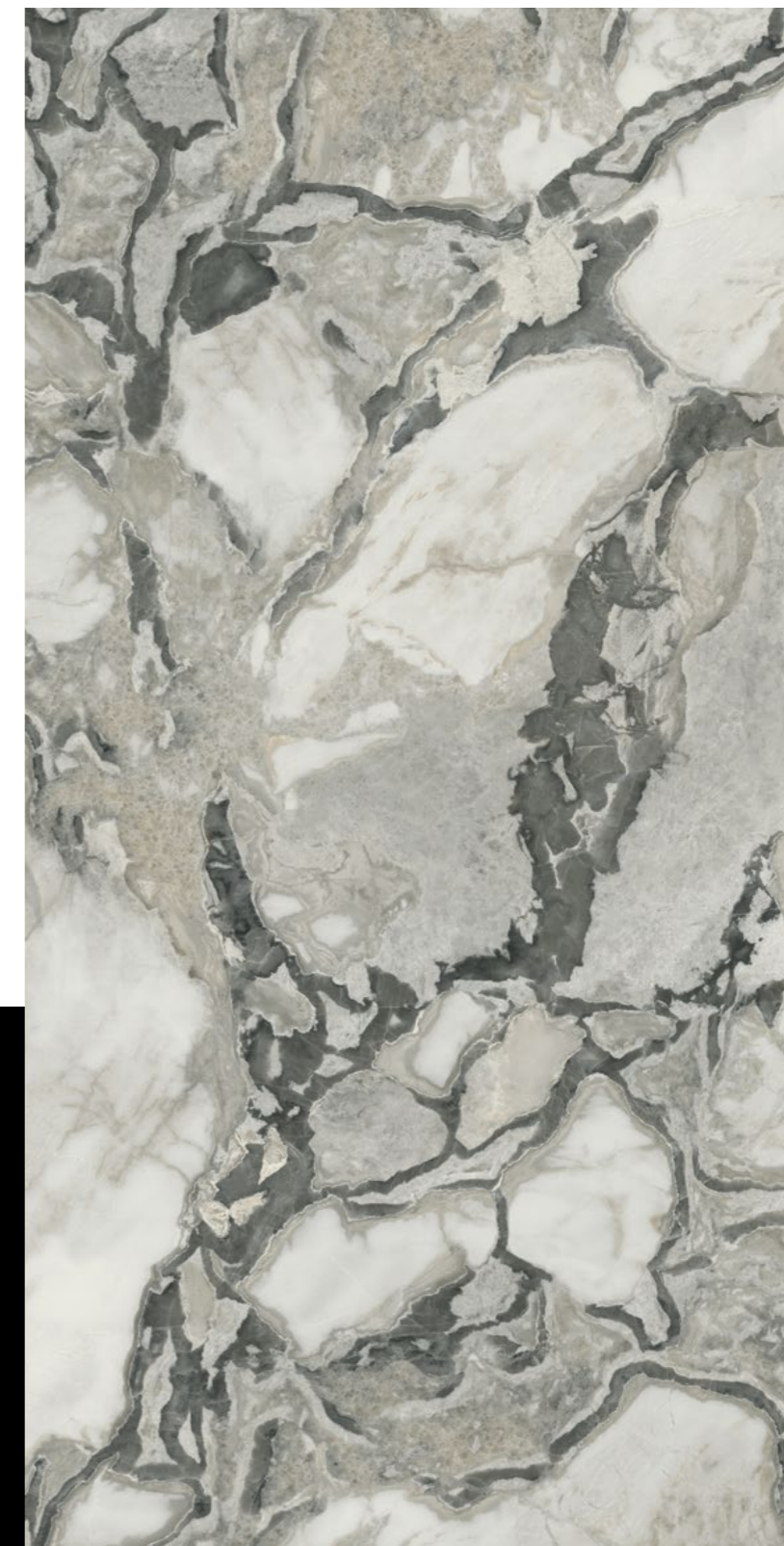

DETAILS

size **3200x1600 mm**

thickness **12mm**

finish **3D Natural**



MARMO ANTICO

BOOK MATCH PATTERN



MEGASLIM
T12 PORCELAIN SLAB

MADE IN ITALY

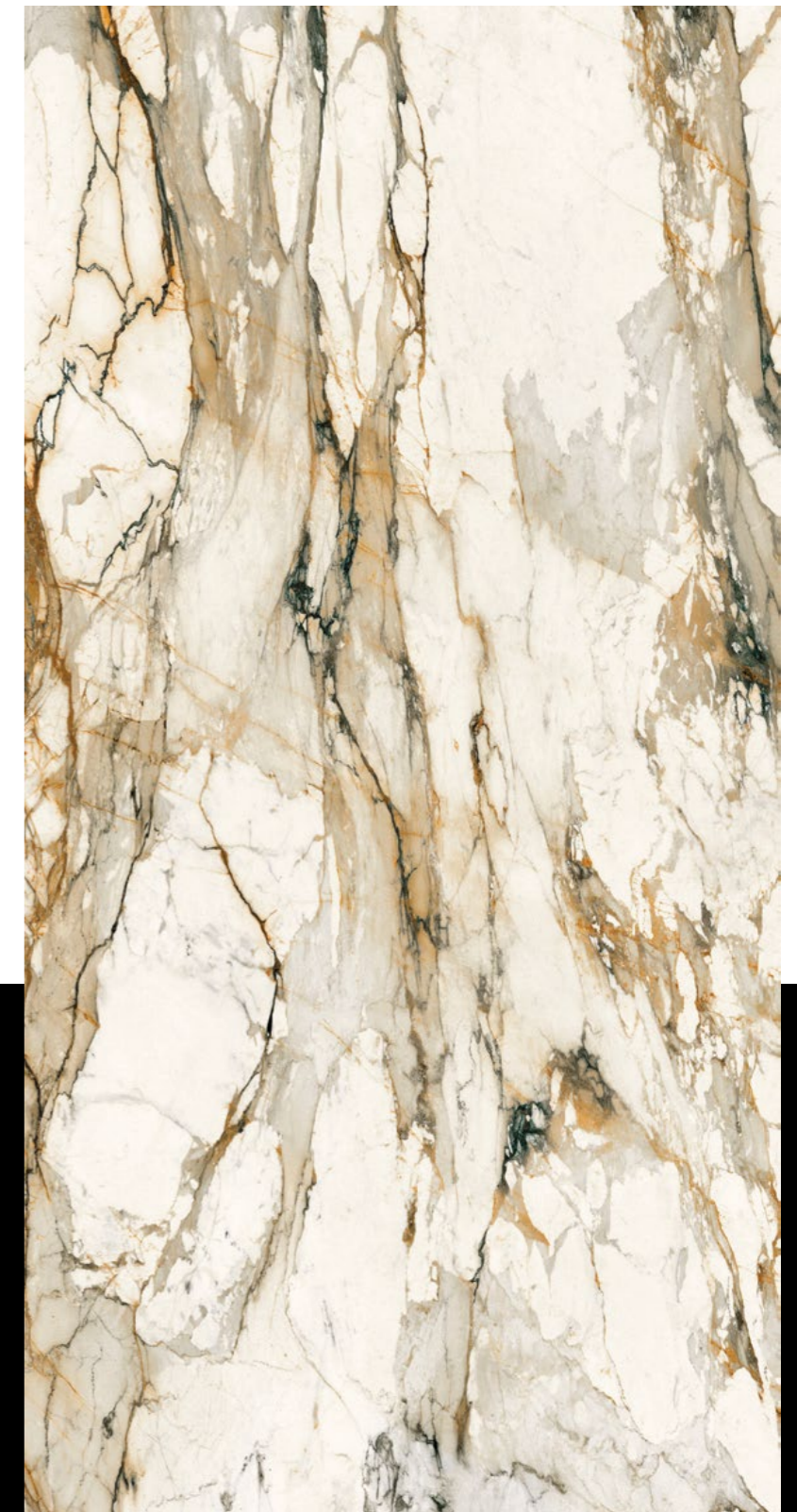

DETAILS

size **3200x1600 mm**

thickness **12mm**

finish **3D Honed**



TRAVERTINE WHITE



MEGASLIM
T12 PORCELAIN SLAB

MADE IN ITALY

BOOK MATCH PATTERN



DETAILS

size **3200x1600 mm**

thickness **12mm**

finish **3D Honed**





MONET

BOOK MATCH PATTERN



MEGASLIM
T12 PORCELAIN SLAB

MADE IN ITALY

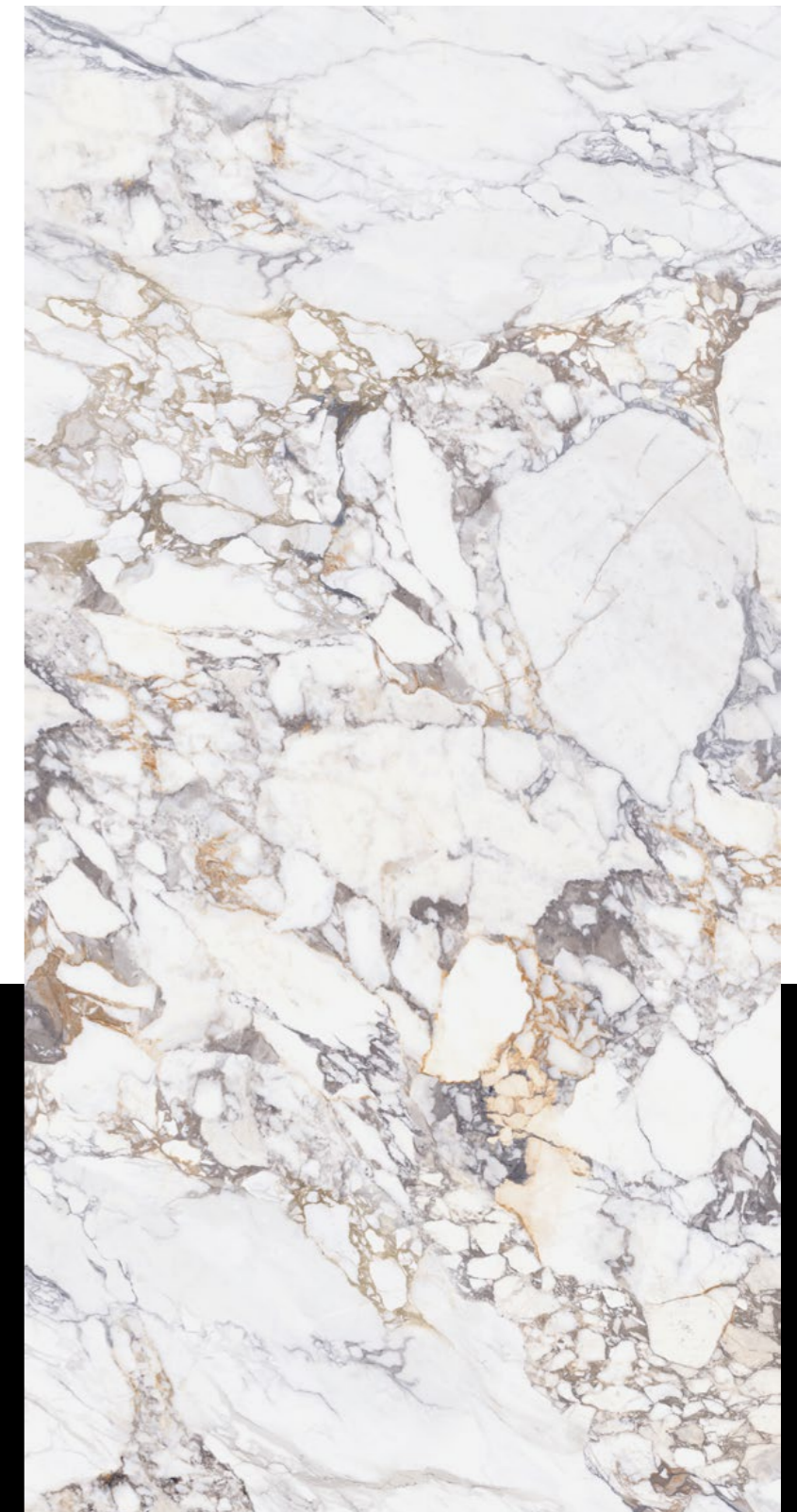

DETAILS

size **3200x1600 mm**

thickness **12mm**

finish **3D Honed**



MEGASLIM
T6 & T12 PORCELAIN SLAB

MADE IN ITALY



TAJ MAHAL MAX

T6 ONLY

RANDOM PATTERN IN 4 DIFFERENT FACES



T12 ONLY

BOOK MATCH PATTERN



DETAILS

size **3200x1600 mm**

thickness **6.5 mm / 12mm**

finish **Honed**



BLUE ROMA

T6 ONLY

RANDOM PATTERN IN 4 DIFFERENT FACES

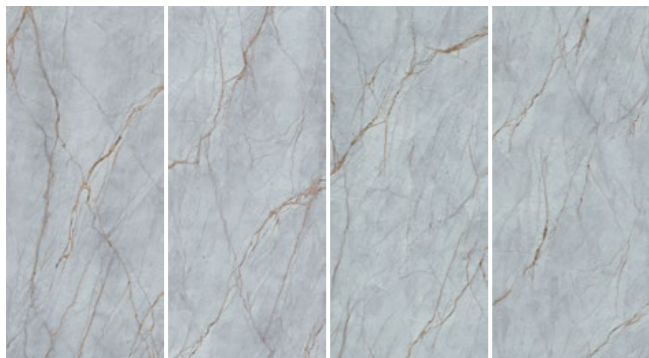

T12 ONLY

BOOK MATCH PATTERN

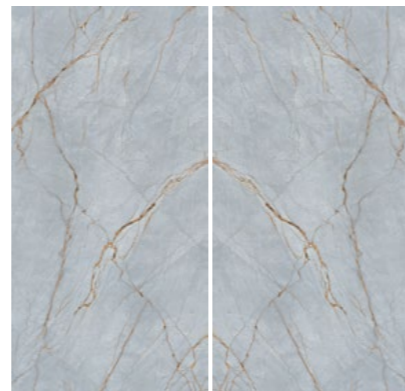

MEGASLIM
T6 & T12 PORCELAIN SLAB



MADE IN SPAIN



DETAILS

size **2800x1200x5.6mm**
3200x1600x12mm

thickness **5.6 mm / 12mm**

finish **3D Natural**



CANELA ROMA

T6 ONLY

RANDOM PATTERN IN 4 DIFFERENT FACES



T12 ONLY

BOOK MATCH PATTERN



MEGASLIM
T6 & T12 PORCELAIN SLAB



MADE IN SPAIN



DETAILS

size **2800x1200x5.6mm**
3200x1600x12mm

thickness **5.6 mm / 12mm**

finish **3D Natural**



TAJ MAHAL

RANDOM PATTERN IN 4 DIFFERENT FACES

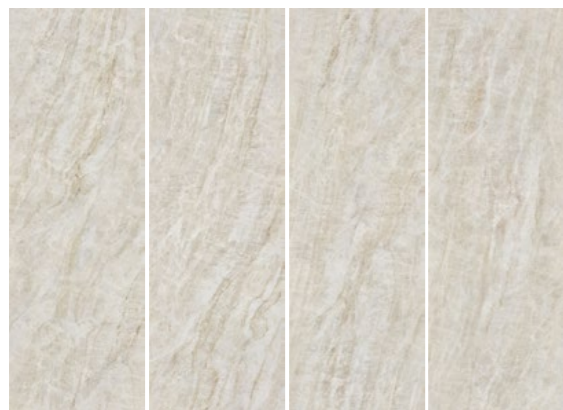

MEGASLIM
T9 THIN PORCELAIN SLAB



DETAILS

size 2700x900 mm

thickness 9 mm

finish Polished & Natural



MEGASLIM
T6 & T12 PORCELAIN SLAB

MADE IN ITALY

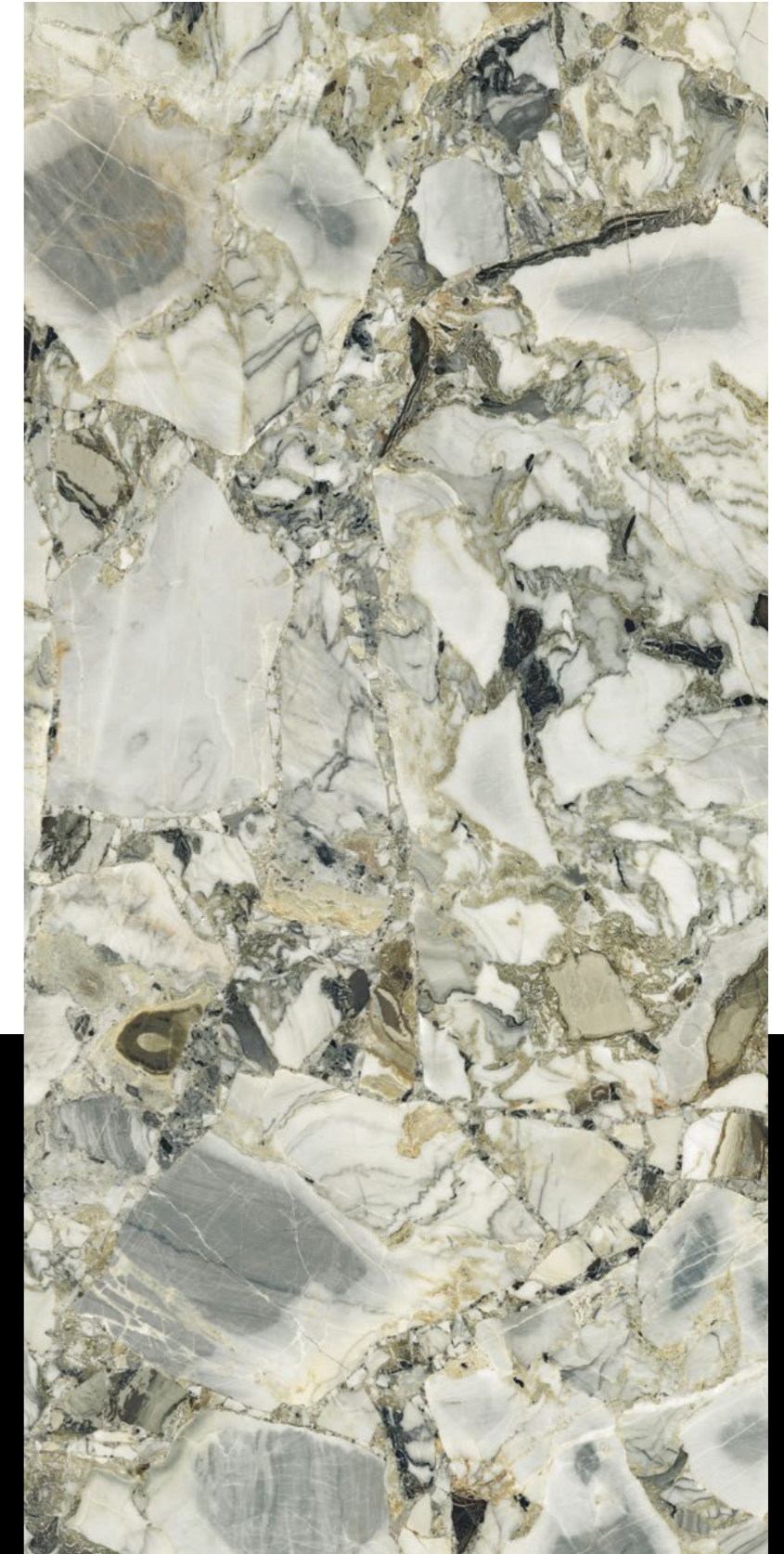

WHITE BEAUTY

T6 ONLY

RANDOM PATTERN IN 3 DIFFERENT FACES



T12 ONLY

SINGLE PATTERN



DETAILS

size **2800x1200x6 mm**
3200x1600x12 mm

thickness **6 mm / 12 mm**

finish **Natural**



MEGASLIM
T6 & T12 PORCELAIN SLAB

MADE IN ITALY

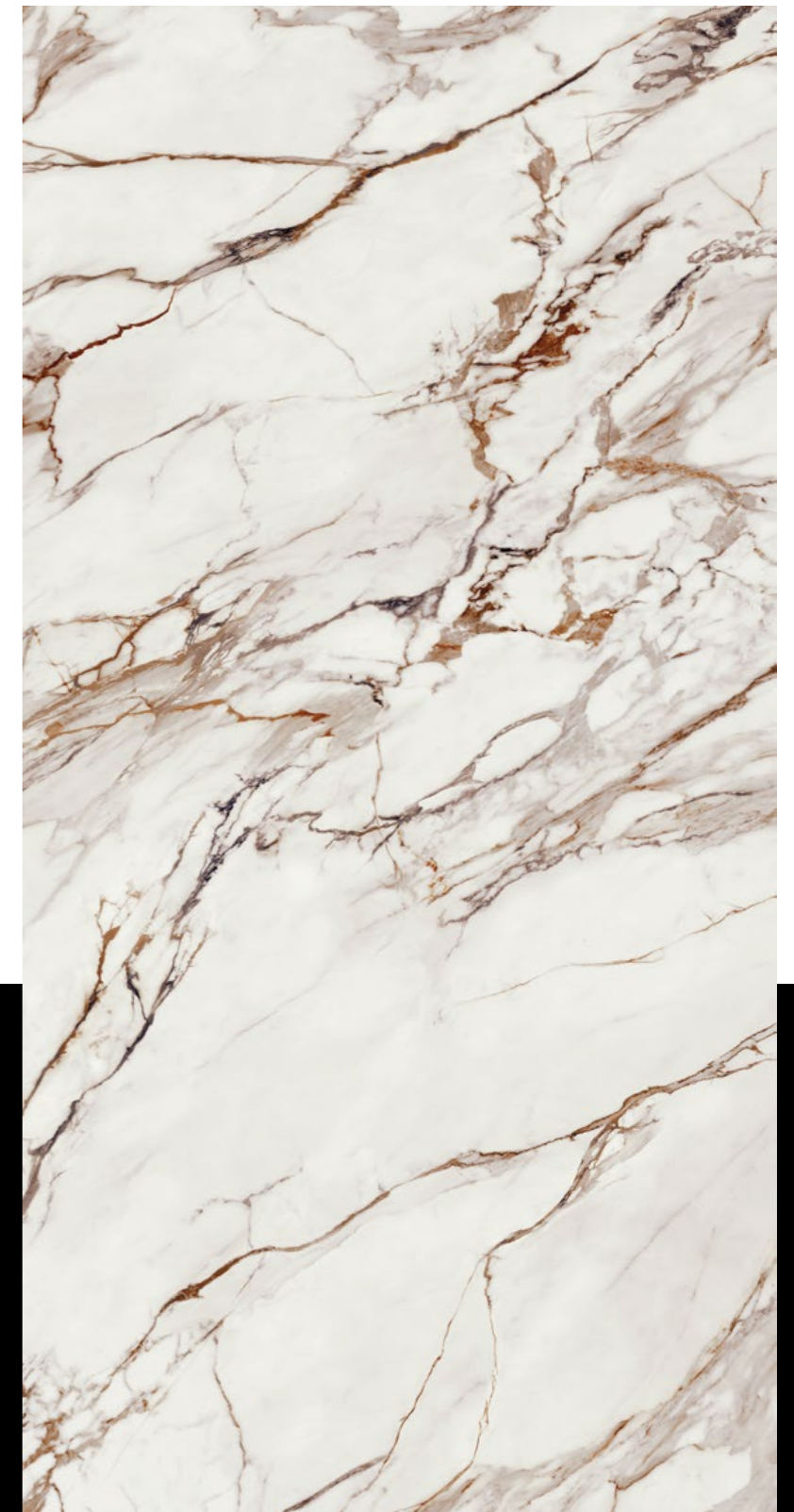

LIGHT RED CALACATTA

BOOK MATCH PATTERN

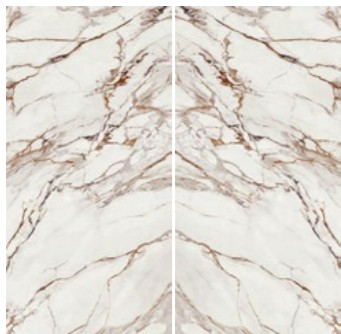

DETAILS

size **3200x1600 mm**

thickness **6.5 mm / 12mm**

finish **Honed**



ARABESCATO VIOLA

BOOK MATCH PATTERN

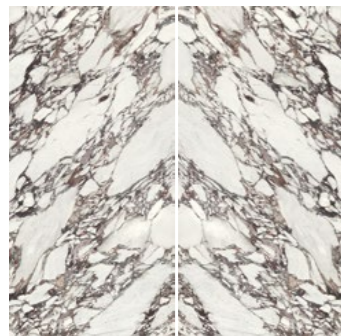

MEGASLIM
T6 & T12 PORCELAIN SLAB



MADE IN ITALY

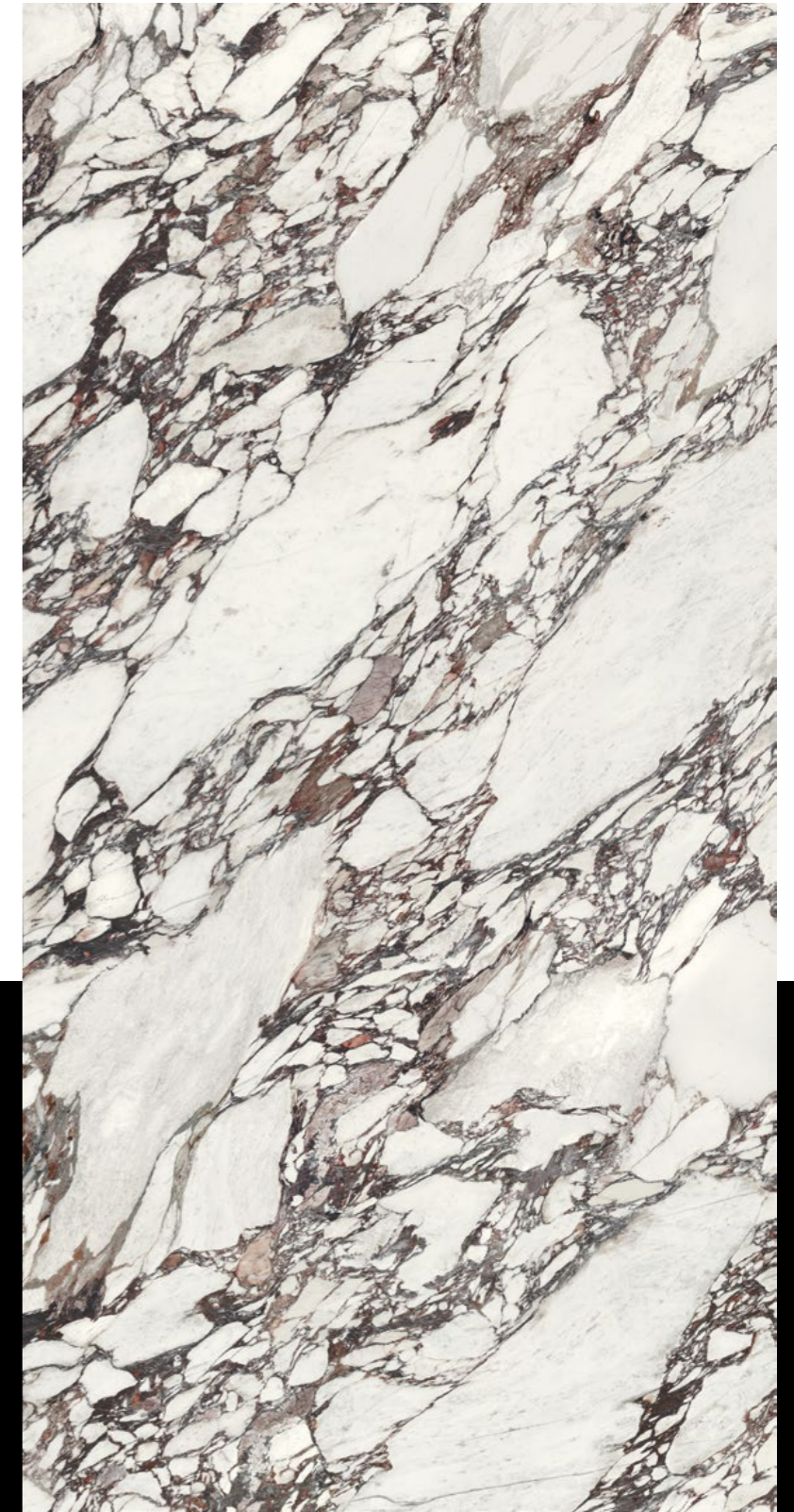

DETAILS

size **3200x1600 mm**

thickness **6.5 mm / 12mm**

finish **Honed**



MEGASLIM
T6 & T12 PORCELAIN SLAB

MADE IN ITALY

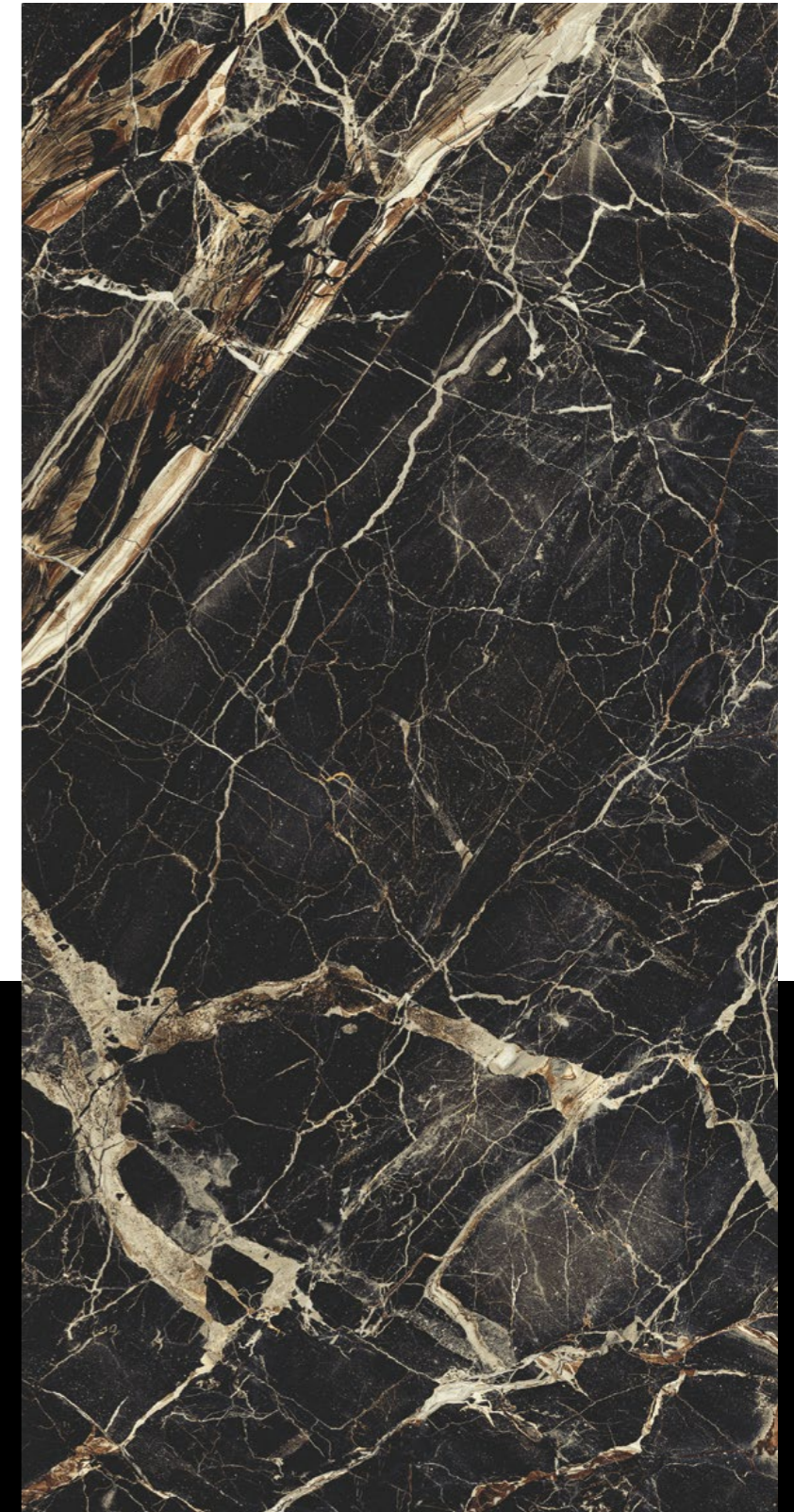

CARAVAGGIO GOLD

BOOK MATCH PATTERN

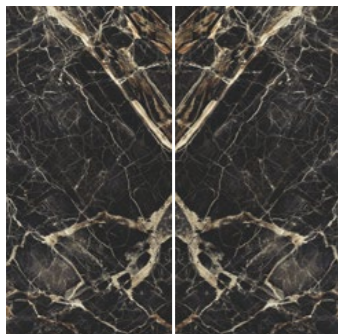

DETAILS

size **3200x1600 mm**

thickness **6.5 mm / 12mm**

finish **Honed**



MEGASLIM
T6 THIN PORCELAIN SLAB

MADE IN ITALY

BRIGHT PRECIOUS

RANDOM PATTERN IN 5 DIFFERENT FACES

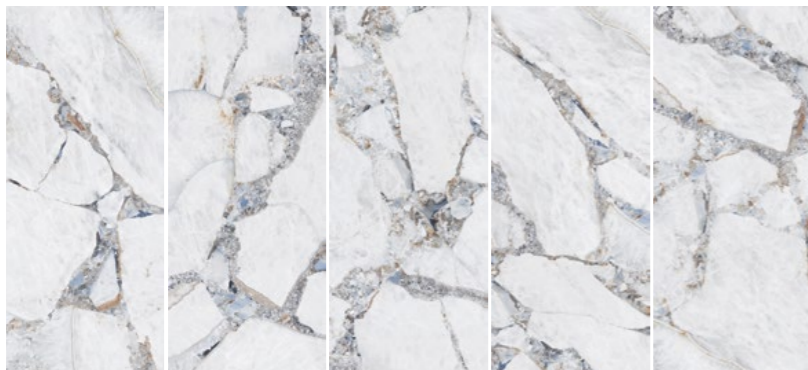

DETAILS

size **2800x1200 mm**

thickness **6 mm**

finish **Natural**





CALACATTA VIOLA

RANDOM PATTERN IN 5 DIFFERENT FACES

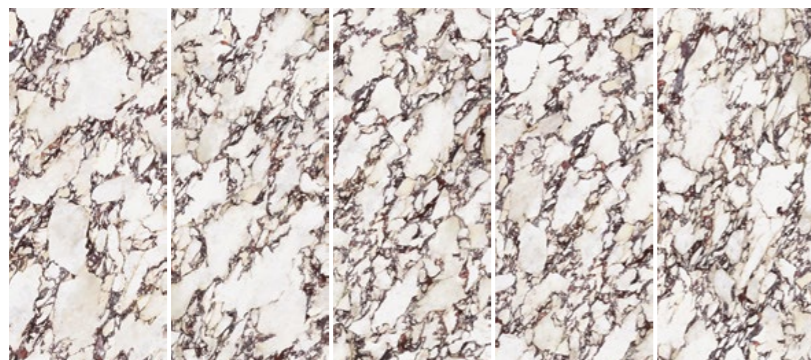

MEGASLIM
T6 THIN PORCELAIN SLAB

MADE IN ITALY

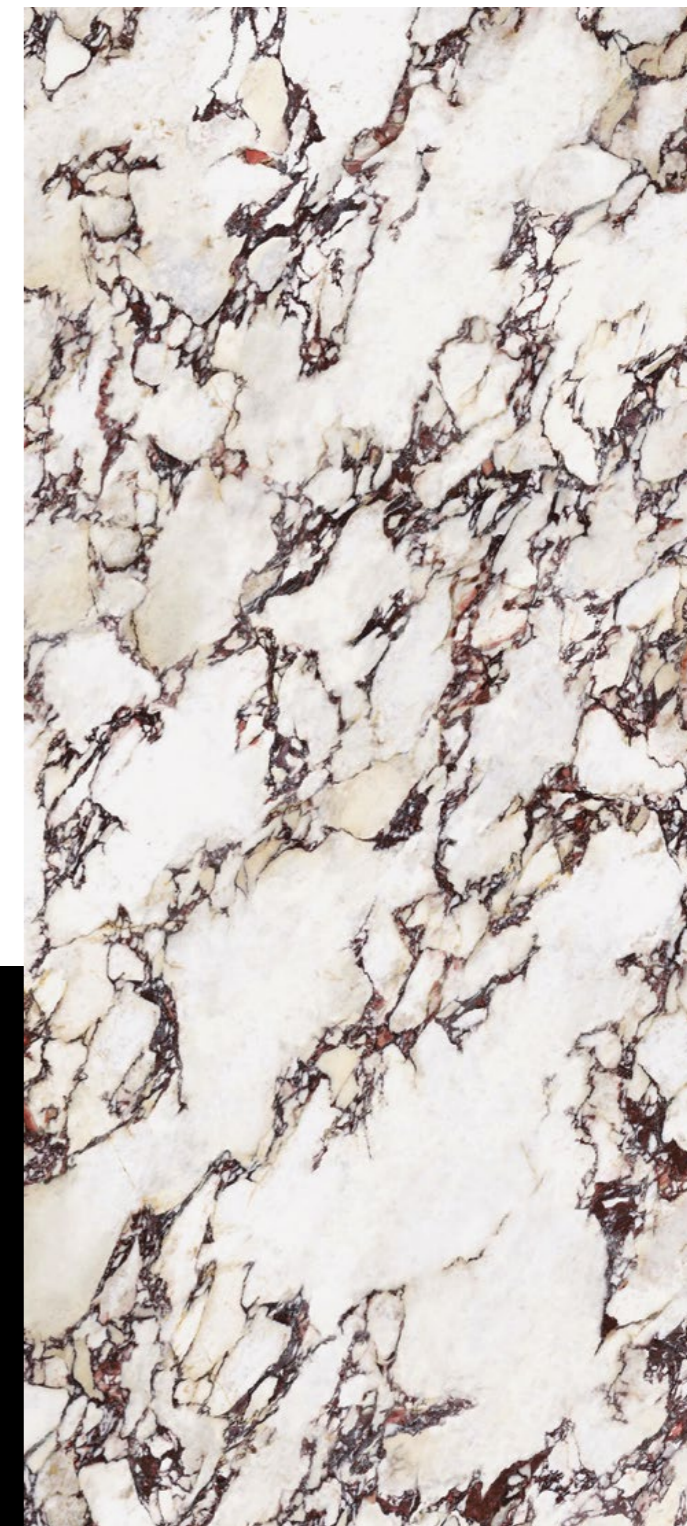

DETAILS

size	2800x1200 mm
thickness	6 mm
finish	Natural



THERME

MEGASLIM
T6 THIN PORCELAIN SLAB

MADE IN ITALY

TIVOLI WHITE VEIN CUT

RANDOM PATTERN IN 4 DIFFERENT FACES

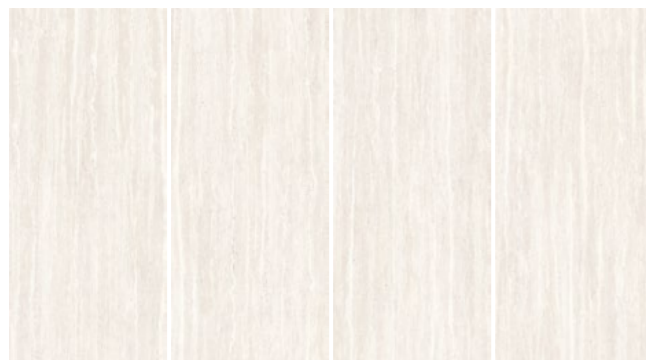

DETAILS

size	2800x1200 mm
thickness	6 mm
finish	Natural





TIVOLI SAND VEIN CUT

RANDOM PATTERN IN 4 DIFFERENT FACES



MEGASLIM
T6 THIN PORCELAIN SLAB

MADE IN ITALY



DETAILS

size 2800x1200 mm

thickness 6 mm

finish Natural



MEGASLIM
T6 THIN PORCELAIN SLAB

MADE IN ITALY

BLACK DIAMOND

FLOW PATTERN IN 3 DIFFERENT FACES

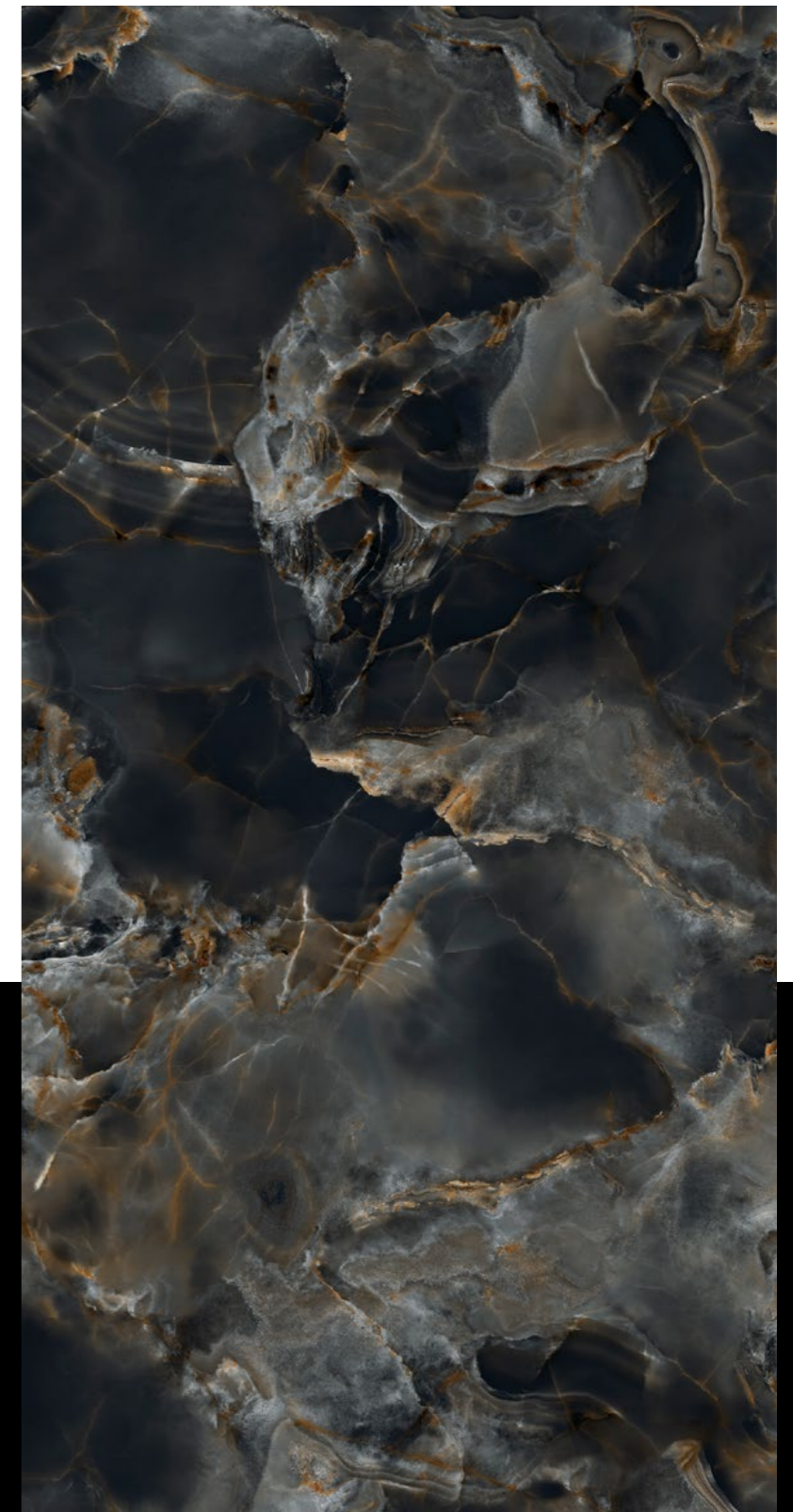
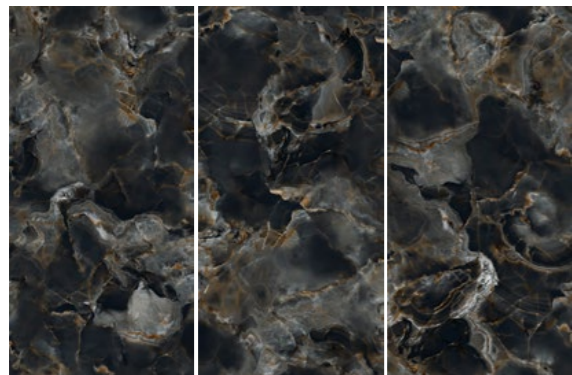

DETAILS

size	3200x1600 mm
thickness	6 mm
finish	Polished



MEGASLIM
T6 THIN PORCELAIN SLAB

MADE IN ITALY

CRYSTAL

FLOW PATTERN IN 3 DIFFERENT FACES



DETAILS

size **3200x1600 mm**

thickness **6 mm**

finish **Polished**



MEGASLIM
T6 THIN PORCELAIN SLAB

MADE IN ITALY

AMBER

FLOW PATTERN IN 3 DIFFERENT FACES



DETAILS

size **3200x1600 mm**

thickness **6 mm**

finish **Polished**





MEGASLIM
T6 THIN PORCELAIN SLAB

MADE IN ITALY



JADE

FLOW PATTERN IN 3 DIFFERENT FACES



DETAILS

size **3200x1600 mm**

thickness **6 mm**

finish **Polished**



MEGASLIM
T6 THIN PORCELAIN SLAB

MADE IN ITALY

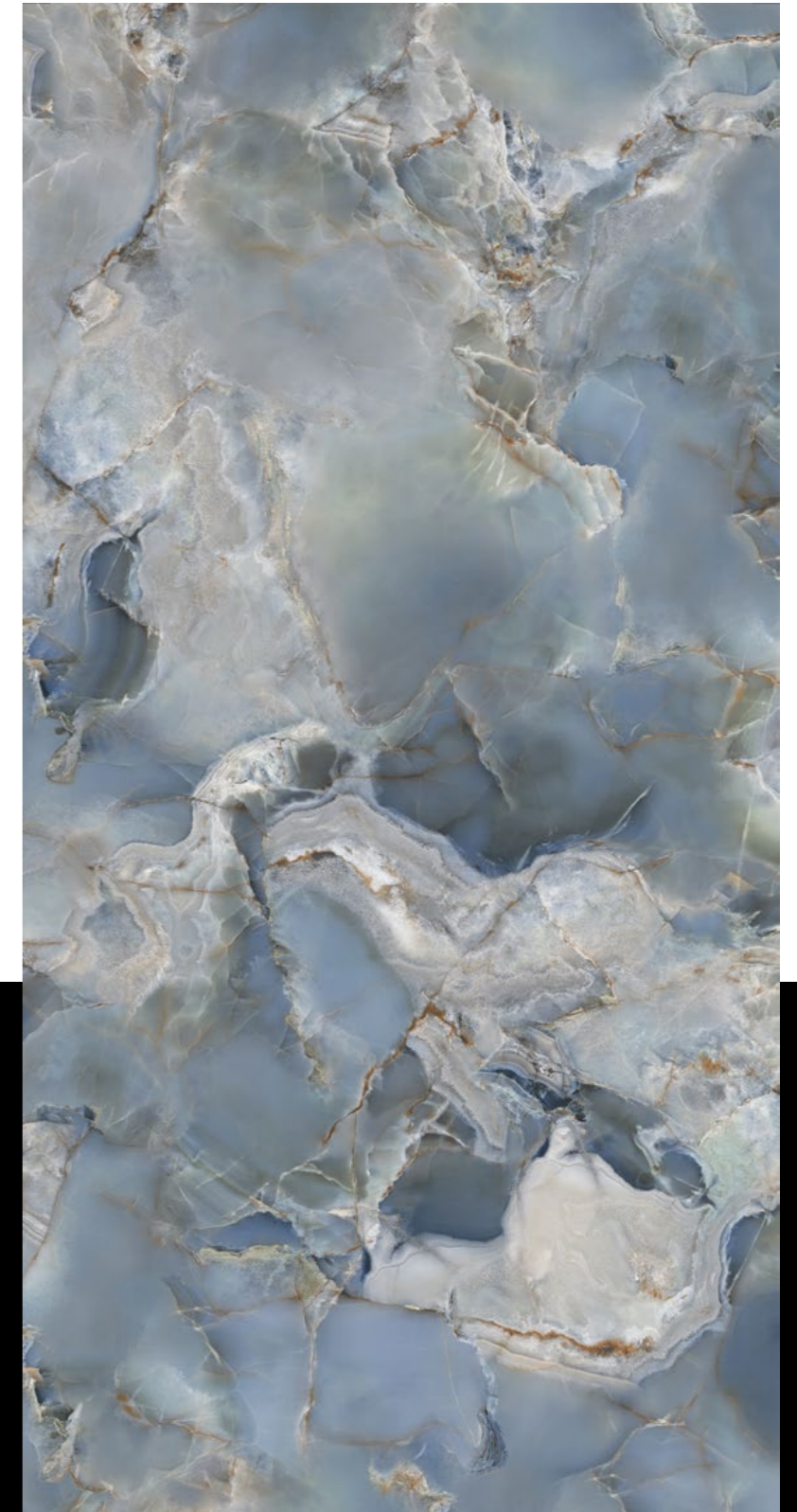

GEMSTONE

FLOW PATTERN IN 3 DIFFERENT FACES

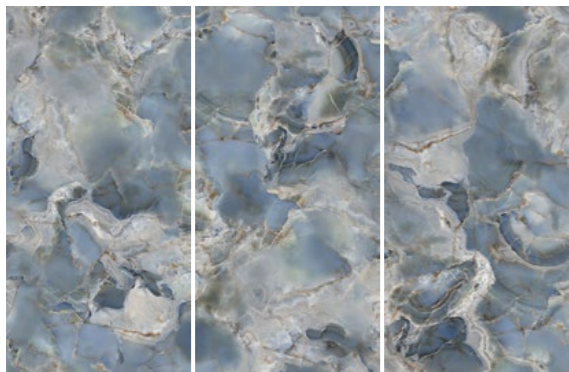

DETAILS

size	3200x1600 mm
thickness	6 mm
finish	Polished



MEGASLIM
T6 & T12 PORCELAIN SLAB

MADE IN ITALY



MACCHIA ANTICA

T6 ONLY

FLOW PATTERN IN 5 DIFFERENT FACES



T12 ONLY

BOOK MATCH PATTERN



DETAILS

size **3200x1600 mm**

thickness **6 mm / 12mm**

finish **Natural**



BALLET

BOOK MATCH PATTERN



MEGASLIM
T6 & T12 PORCELAIN SLAB

MADE IN ITALY



DETAILS

size **3200x1600 mm**

thickness **6.5 mm / 12 mm**

finish **Natural**



INVISIBLE GREY

MEGASLIM | T6 THIN PORCELAIN SLAB

 MADE IN ITALY

RANDOM PATTERN IN 6 DIFFERENT FACES

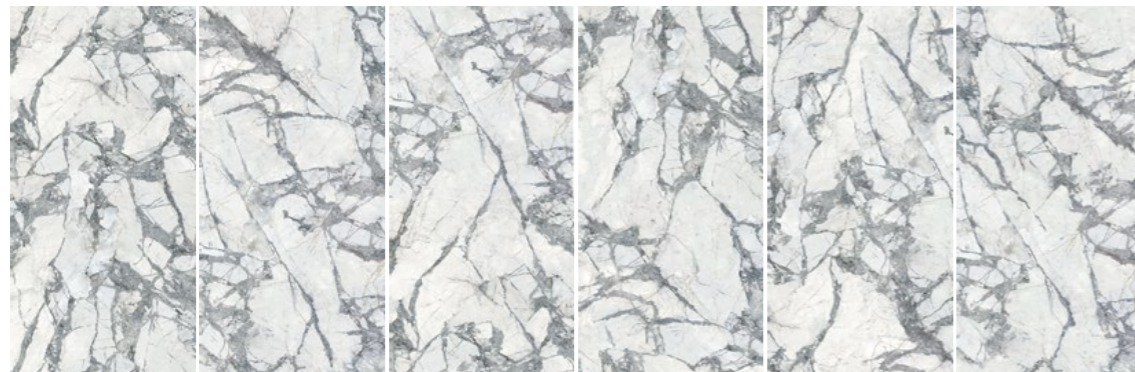

DETAILS

size	thickness	finish
2700x1200 mm	6mm	Natural



CALACATTA GOLD

MEGASLIM | T6 & T12 PORCELAIN SLAB

 MADE IN ITALY

T6 ONLY /

RANDOM PATTERN IN 4 DIFFERENT FACES



T12 ONLY /

BOOK MATCH PATTERN

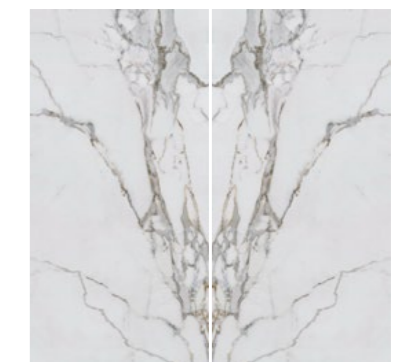

DETAILS

size	thickness	finish
3200x1600 mm	6mm / 12mm	Natural



STATUARIO REALE

MEGASLIM | T6 & T12 PORCELAIN SLAB

 MADE IN ITALY

T6 ONLY

FLOW PATTERN IN 6 DIFFERENT FACES



T12 ONLY

BOOK MATCH PATTERN

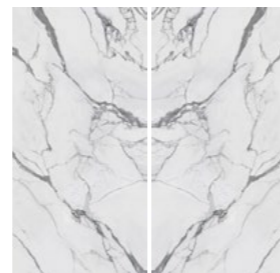

DETAILS

size	thickness	finish
3200x1600 mm	6mm / 12mm	Natural T6 / T12 Polished T6



CALACATTA ORO

MEGASLIM | T6 & T12 PORCELAIN SLAB

 MADE IN ITALY

T6 ONLY

BOOK MATCH PATTERN

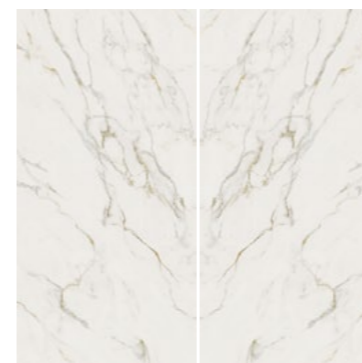

T12 ONLY

BOOK MATCH PATTERN

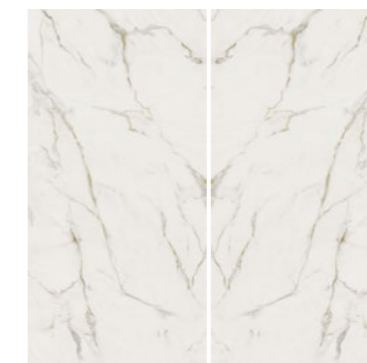

DETAILS

size	thickness	finish
3200x1600 mm	6.5mm / 12mm	Natural



LILAC

MEGASLIM | T6 THIN PORCELAIN SLAB



RANDOM PATTERN IN 7 DIFFERENT FACES - 3200X1600
 11 DIFFERENT FACES - 2800X1200
 *Also available in 22 faces - 1200x1200

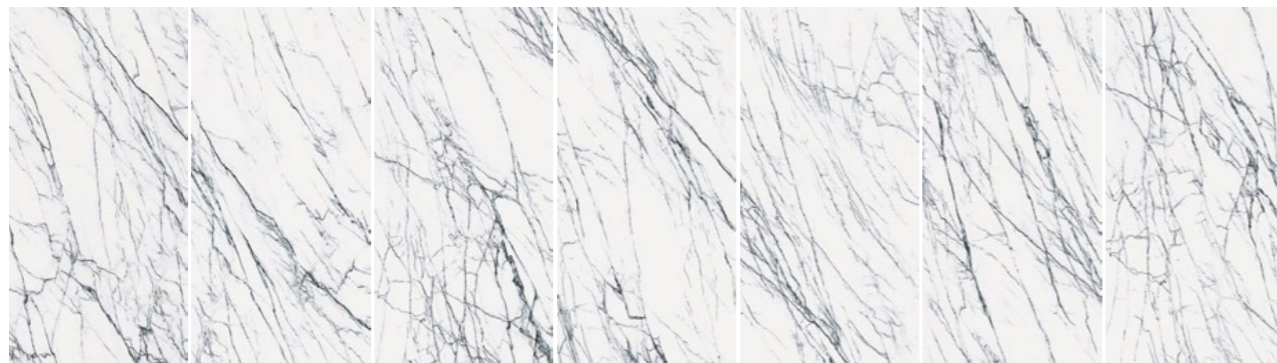

DETAILS

size	thickness	finish
1200x1200 mm	6mm	Natural
2800x1200 mm		
3200x1600 mm		



SUPER WHITE DOLOMITE

MEGASLIM | T6 & T12 PORCELAIN SLAB



T6 ONLY (NATURAL FINISH)

T12 ONLY (SATIN FINISH)

RANDOM PATTERN IN 5 DIFFERENT FACES

SINGLE PATTERN



DETAILS

size	thickness	finish
2800x1200 mm	6mm / 12mm	Natural T6
3200x1600 mm		Satin T12



STATUARIO SUPERIORE

MEGASLIM | T6 THIN PORCELAIN SLAB

 MADE IN ITALY

FLOW PATTERN IN 6 DIFFERENT FACES



DETAILS

size	thickness	finish
2700x1200 mm	6mm	Natural



PIERRE BLACK

MEGASLIM | T6 THIN PORCELAIN SLAB

 MADE IN ITALY

RANDOM PATTERN IN 6 DIFFERENT FACES

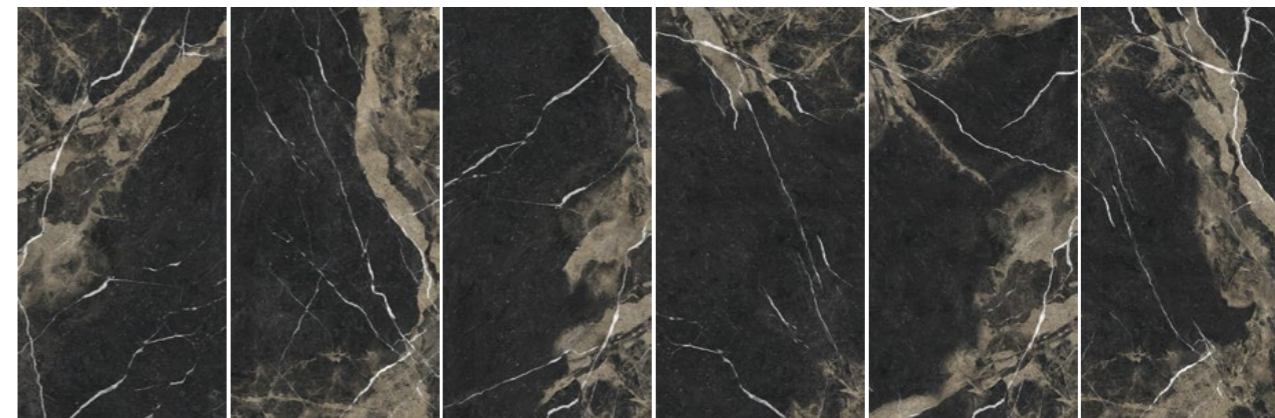

DETAILS

size	thickness	finish
2700x1200 mm	6mm	Natural



MARQUINA BLACK

MEGASLIM | T6 THIN PORCELAIN SLAB



RANDOM PATTERN IN 7 DIFFERENT FACES

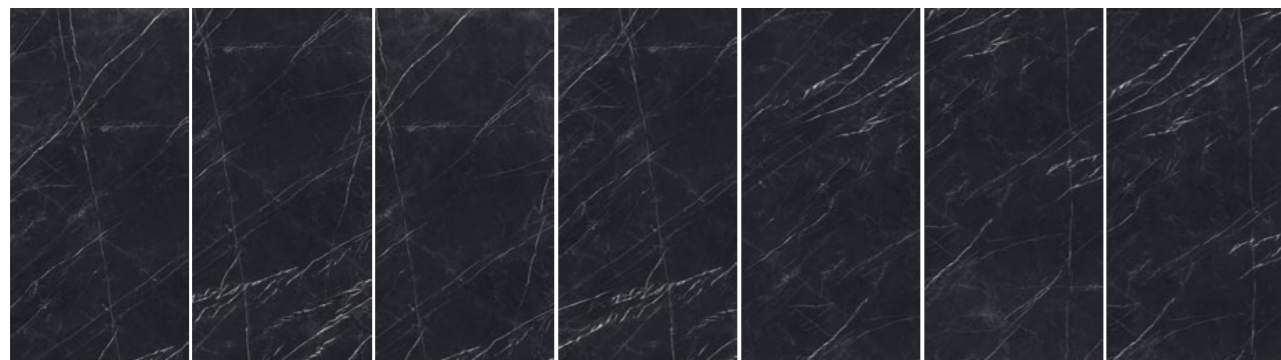

DETAILS

size	thickness	finish
2800x1200 mm	6mm	Natural



ARABESCATO

MEGASLIM | T6 THIN PORCELAIN SLAB



RANDOM PATTERN IN 12 DIFFERENT FACES



DETAILS

size	thickness	finish
2800x1200 mm	6mm	Natural



CELLINI

MEGASLIM | T6 THIN PORCELAIN SLAB

 MADE IN ITALY

BOOK MATCH PATTERN

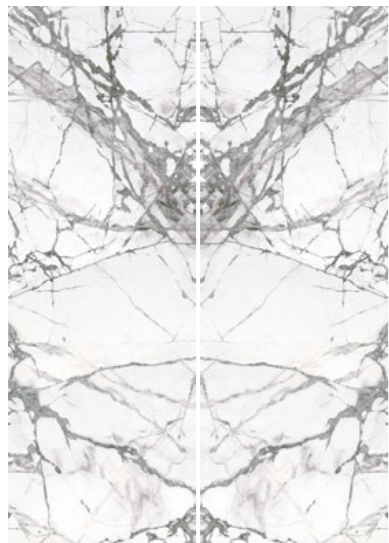

DETAILS

size	2700x900 mm
thickness	6 mm
finish	Natural

PALLADIO

MEGASLIM | T6 THIN PORCELAIN SLAB

 MADE IN ITALY

BOOK MATCH PATTERN



DETAILS

size	2700x900 mm
thickness	6 mm
finish	Natural

MAGMA

MADE IN ITALY

NATURAL



RANDOM PATTERN IN 4 DIFFERENT FACES



MAGMA

MADE IN ITALY

AVIO

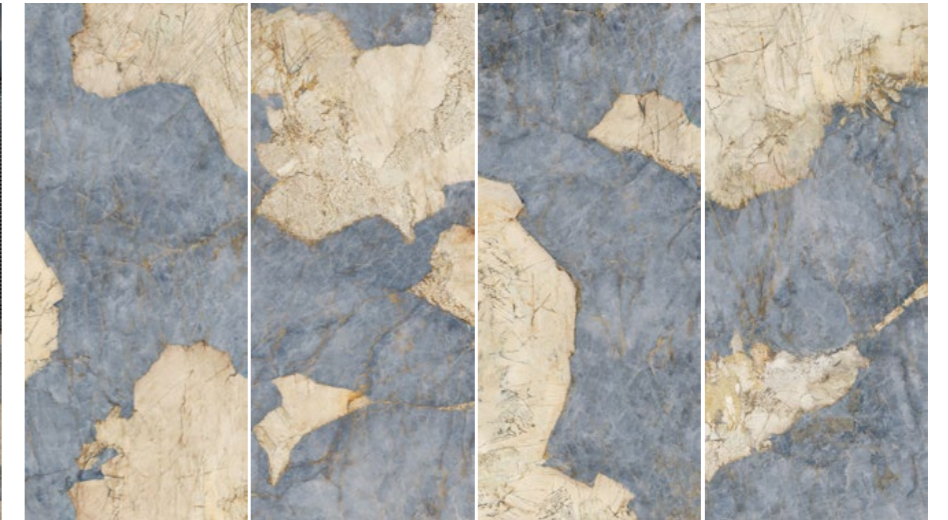

RANDOM PATTERN IN 4 DIFFERENT FACES

BLACK & WHITE

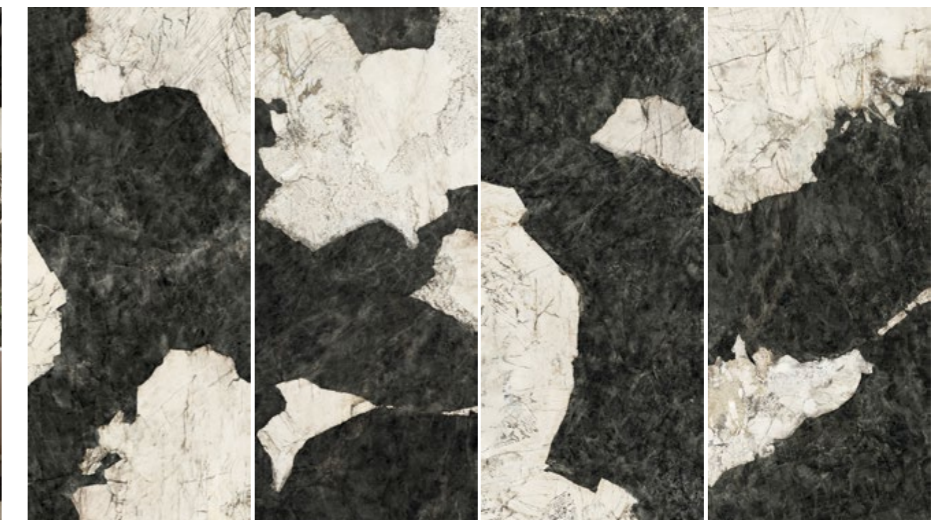

RANDOM PATTERN IN 4 DIFFERENT FACES

MEGASLIM
T6 THIN PORCELAIN SLAB



DETAILS

size	2800x1200 mm
thickness	6 mm
finish	Polished



ABSOLUTE

MEGASLIM | T6 & T12 PORCELAIN SLAB

 MADE IN ITALY

BOOK MATCH PATTERN



DETAILS

size **3200x1600**

thickness **6.5mm / 12mm**

finish **Natural**



BASALTINA NERO

MEGASLIM | T6 & T12 PORCELAIN SLAB

 MADE IN ITALY

SINGLE PATTERN



DETAILS

size **3200x1600 mm**

thickness **6.5mm / 12 mm**

finish **Natural (Leather)**

EMOTION EUPHORIA

MEGASLIM | T6 THIN PORCELAIN SLAB

MADE IN ITALY

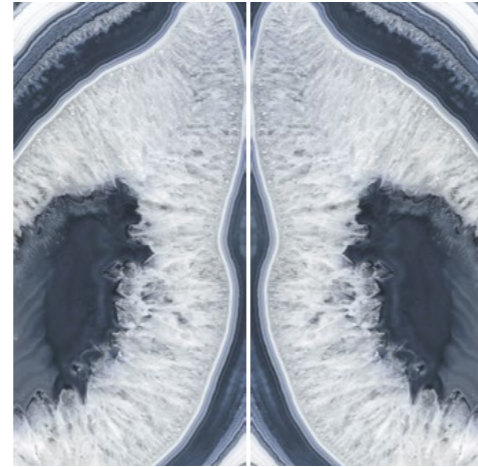

BOOK MATCH PATTERN

DETAILS

size	thickness	finish
3200x1600 mm	6.5mm	Polished



BARDIGLIO

MEGASLIM | T6 THIN PORCELAIN SLAB

MADE IN ITALY



RANDOM PATTERN IN 9 DIFFERENT FACES

DETAILS

size	thickness	finish
3200x1600 mm	6mm	Polished

STATUARIO EXTRA

MEGASLIM | T6 THIN PORCELAIN SLAB

MADE IN ITALY

FLOW PATTERN IN 7 DIFFERENT FACES



DETAILS

size	thickness	finish
3200x1600 mm	6mm	Honed&Polished



PIETRA GRIGIA

MEGASLIM | T6 & T12 PORCELAIN SLAB

 MADE IN ITALY



BOOK MATCH PATTERN

DETAILS

size	thickness	finish
3200x1600 mm	6.5mm / 12mm	Natural

GRIGIO VENEZIANO

MEGASLIM | T6 & T12 PORCELAIN SLAB

 MADE IN ITALY

BOOK MATCH PATTERN

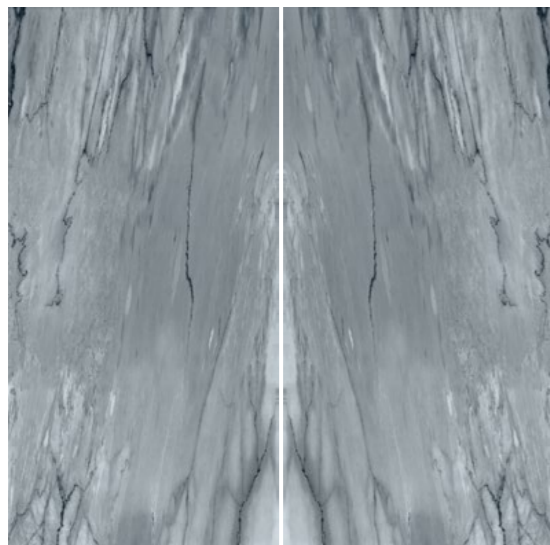

DETAILS

size	3200x1600
thickness	6.5mm / 12mm
finish	Natural

PIETRA TAUPE

MEGASLIM | T6 THIN PORCELAIN SLAB

 MADE IN ITALY



RANDOM PATTERN IN 12 DIFFERENT FACES

DETAILS

size	thickness	finish
2700x1200 mm	6mm	Natural



MACCHIA VECCHIA

MEGASLIM | T6 & T20 PORCELAIN SLAB



FLOW PATTERN IN 3 DIFFERENT FACES

DETAILS

size	thickness	finish
3200x1600 mm	6mm / 20mm	Polished

INVISIBLE GOLD

MEGASLIM | T6 & T12 PORCELAIN SLAB

FLOW PATTERN IN 2 DIFFERENT FACES



DETAILS

size	3200x1600
thickness	6mm / 12mm
finish	Polished(T12) & Matt (T6)

PACISTA

MEGASLIM | T6 & T12 PORCELAIN SLAB

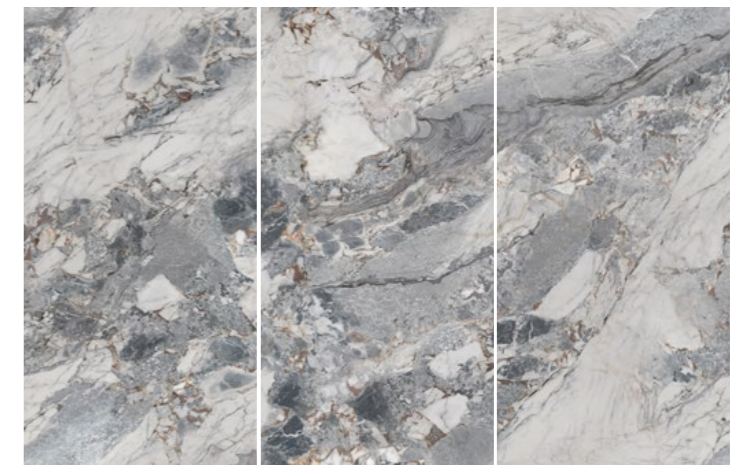
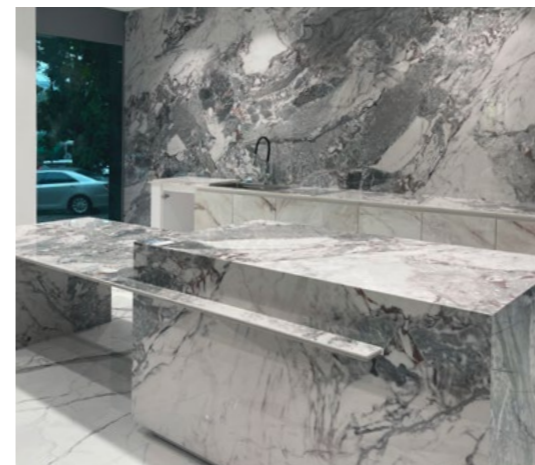

FLOW PATTERN IN 3 DIFFERENT FACES

DETAILS

size	thickness	finish
3200x1600 mm	6mm / 12mm	Matt



CALACATTA VAGLI

MEGASLIM | VEINTECH™ FULL BODY PORCELAIN SLAB

SINGLE PATTERN

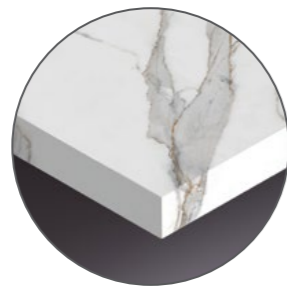
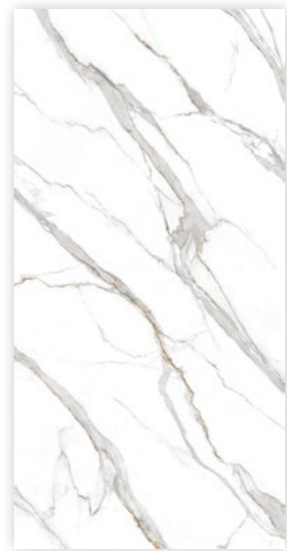

DETAILS

size **3200x1600**

thickness **12mm**

finish **Polished & Natural**



CALACATTA EXTRA

MEGASLIM | VEINTECH™ FULL BODY PORCELAIN SLAB

SINGLE PATTERN



DETAILS

size **3200x1600**

thickness **12mm**

finish **Polished**



STATUARIO PREMIUM



MEGASLIM | T6 THIN PORCELAIN SLAB

FLOW PATTERN IN 4 DIFFERENT FACES - 3200X1600

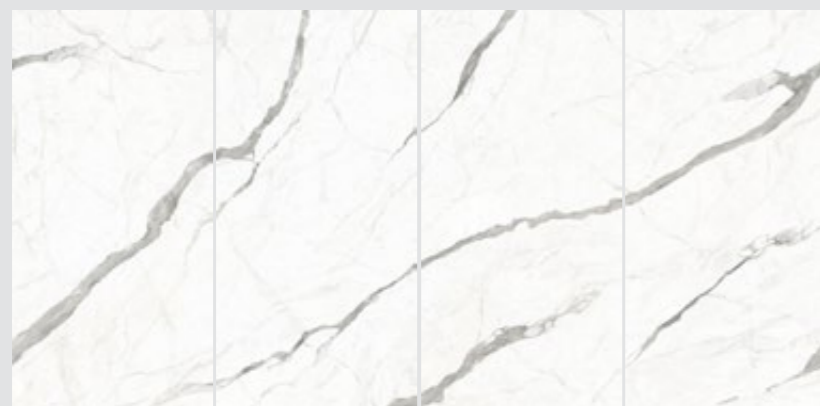

DETAILS

size	3200x1600 mm
thickness	6.5 mm
finish	Honed & Polished

CALACATTA ULTIMATE

MEGASLIM | T6 & T12 PORCELAIN SLAB

FLOW PATTERN IN 3 DIFFERENT FACES



DETAILS

size	3200x1600 mm
thickness	5.8 mm / 12mm
finish	Polished / Natural (T6 only)

VERDE

MEGASLIM | VEINTECH™ FULL BODY PORCELAIN SLAB

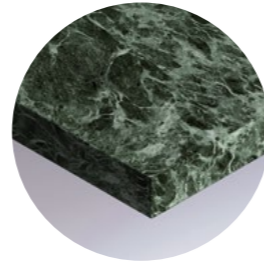
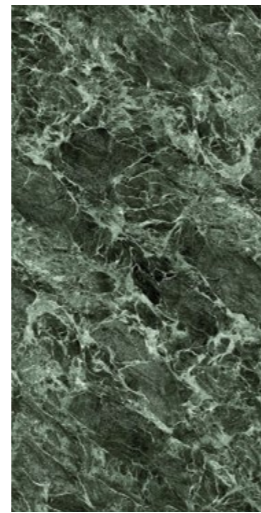

SINGLE PATTERN

DETAILS

size	thickness	finish
3200x1600 mm	12mm	Polished

METRO GREY

MEGASLIM | T12 PORCELAIN SLAB



SINGLE PATTERN

DETAILS

size	thickness	finish
3200x1600 mm	12mm	Natural

AZUL

MEGASLIM | VEINTECH™ FULL BODY PORCELAIN SLAB

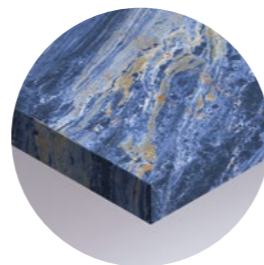
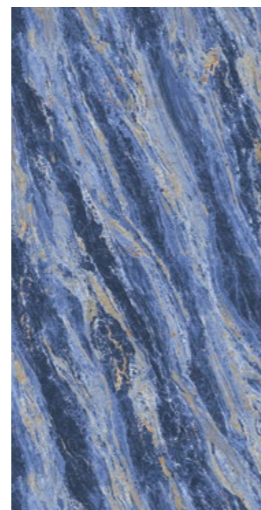

SINGLE PATTERN

DETAILS

size	thickness	finish
3200x1600 mm	12mm	Polished

SUPER BLACK

MEGASLIM | T12 PORCELAIN SLAB

















SINGLE PATTERN

DETAILS

size	thickness	finish
3200x1600 mm	12mm	Natural

TECHNICAL DETAILS

Dry-pressed Porcelain Stoneware Slabs

Specifications	Standars	Test Results
 Product Classification	UNI EN 14411 - Appendix G ISO 13006	Group B1a GL
 Dimensional characteristics	UNI EN ISO 10545-2	Conforming
 Water absorption	UNI EN ISO 10545-3	Conforming
 Breaking strength	UNI EN ISO 10545-4	Conforming
Breaking module		Conforming
 Deep abrasion resistance of unglazed tiles	UNI EN ISO 10545-6	N/A
Abrasion resistance of glazed tiles	UNI EN ISO 10545-7	III - V
 Linear thermal expansion	UNI EN ISO 10545-8	$6 \times 10^{-6} \text{ C}^{-1}$
 Thermal shock resistance	UNI EN ISO 10545-9	Resistant
 Crazeing resistance	UNI EN ISO 10545-11	Resistant
 Frost resistance	UNI EN ISO 10545-12	Resistant
 Chemical resistance	UNI EN ISO 10545-13	Resistant
 Stain resistance	UNI EN ISO 10545-14	Resistant
 Colour stability upon exposure to light	DIN 51094	Conforming
 Friction coefficient (slip level)	DIN 51130	Available on request
	DIN 51097	Available on request
	ASTM C1028 C.O.F.	Available on request
	B.C.R.	Available on request
	DCOF (BOOT 3000 - section 9.6 ANSI 137.2012)	Available on request
 Salt resistance	NaCl	Resistant
 Reaction to fire	UNI EN 13501-1-2009	Available on request

FEATURES

- Thickness from 5.8mm to 12mm
- Lightweight thin panels
- Resistant to fungi
- Resistant to UV light
- Resistant to heat
- Easily cut and drill on site
- Easy to clean and maintain
- Highly compacted porcelain stoneware
- Extra large panel sizes, from 1200x1200 to 3200x1600*

*Sizes and thicknesses subject to colour selection. Panels are supplied randomly.

APPLICATIONS

- Suitable for internal and external use
- Suitable for wet areas
- Suitable for bench tops, vanities, splashback and feature walls

T12 THIN PORCELAIN SLABS TOP EDGE PROFILES

Shark Nose

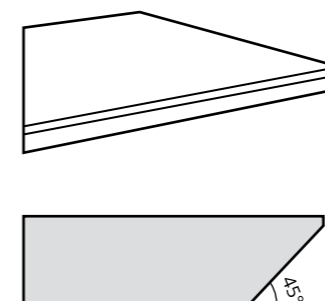

Square Edge

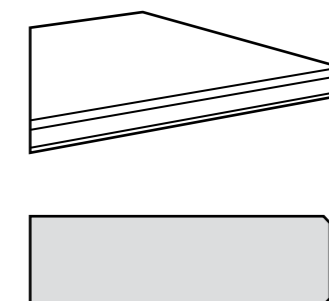

Mitred Edge

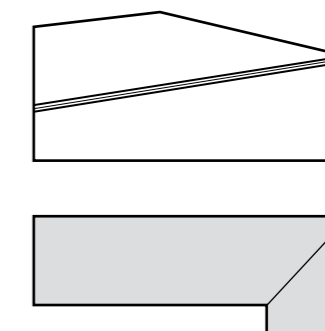

GUIDELINES

MEGASLIM® BENCH TOPS AND VANITIES BY EVERSTONE®

Through the Megaslim® vast assortment of colours and finishes, Everstone can offer the most advanced range of ready-to-install 6mm and 12mm thick countertops.

AVAILABLE STOCK SIZES AND FINISHES

Standard benchtops are cut from 3200x1600x12mm full body porcelain panels, this allows for the manufacturing of most common bench tops requirements with a minimal amount of joints in Polished, Honed, and Matt surfaces.

DESIGN, INSTALLATION, AND MAINTENANCE GUIDE

Kitchen / Vanity cabinets checklist

The Megaslim® porcelain countertops consist of rigid high density, 6mm and 12mm thick, porcelain panels that require minimal substrate support. Tops are factory cut to match requirements with minimal on-site involvement.

No matter how the Megaslim® preassembled porcelain countertops are used, whether on a new installation or when refurbishing existing cabinets units, it is important to always plan for correct components allocation and tops dimensional limits.

When more than one unit length is required, all joints in the tops should be well supported underneath and preferably located over existing cabinet panel edges.

Any appliance weighing more than 5kg should be adequately supported by a dedicated additional frame. Avoid over-tightening or fixing any surface fittings directly to the Megaslim® panels.

Installation of countertops

Prior to installing the Megaslim® countertops, care should be taken to check the cabinets and base units for strength and stability and that each unit is correctly fastened to the wall and each other. The surface of the cabinets must be flush and free from any obstructions. Make allowance for any out of square cabinet if necessary.

The Megaslim® countertops should be placed over sound solid and truly flat cabinet frames and where required, allow for additional support to the rear and cross members of the cabinets using additional rail of an approximate dimension of 100mm to 150mm in width.

When required, any cut-outs should be located well within the limits of a single cabinet unit and placed not less than 80mm from any side joint. For square cut-outs always allow for a minimum radius of 5mm at each corner. Use only wet cutting tools to avoid generating excess heat to the tops. To adhere the tops to the cabinet, apply a continuous 10mm thick bead of adhesive over the edges of the cabinet. Glue down the Megaslim® countertops allowing a small gap between the countertop rear edge and the wall face of approximately 3 to 5mm. level adjacent tops before the adhesive cures. Once tops are installed, allow sufficient time for the bonding adhesive to cure before any additional required cutting is performed.

When overhang is required, allow adequate support. If necessary, make use of metal angle as support and adequate additional rails as spacers.

Adhesive recommendations

- **Megaslim® to cabinets:** Sikaflex 252, Mapei Adesilex G19, or similar Polyurethane adhesive.
- **Megaslim® to Megaslim®:** Tenax EpoxGres or Akemi Akepox 5010
- **Megaslim® to perimeter:** suitable colour natural curing silicon
- **Megaslim® to splashback:** Laticrete 345 Platinum Adhesive
- **Megaslim® patching:** Inegra Xi Bonder, Tenax EpoxGres or Akemi Akepox 5010

Care and Maintenance

The Megaslim® porcelain panels are high-quality non-porous stain, heat, and scratch-resistant, which require minimum maintenance. Spills should be cleaned using a common household detergent and rinsed with clean water. Do not use it as a chopping board.

Routine cleaning – best method to minimise stubborn stains is to wash away stains such as red wine, food, oil, or corrosive drinks by using warm water and small quantities of a mild and non-abrasive household cleaning product with a soft, non-abrasive cloth. Do not use products that have high alkaline or acidic pH levels, such as oven or drain cleaning solutions, especially on polished surfaces.

Stubborn stains – Use a nonabrasive cleaning product, microfiber cloth, or mild household cleaning products that are cream-based. To remove other hard substances that may adhere to surfaces, always use a plastic scraper to gently remove the material. Avoid the use of industrial harsh chemicals on the surface of the material, such as paints, paint strippers, permanent markers, and inks.

Heat resistant – although Megaslim® is thermal shock resistant, it is always advisable to use a heat mat or similar as normal practice when placing hot pots on the bench.

Scratch-resistant – Megaslim® panels have a very hard surface and will easily withstand daily normal use. Even so, we recommend using cutting boards and avoiding sliding heavy metallic objects along the surface.

Wall and Floor Cladding

The T6 panels are best suited for wall cladding for internal or external wall cladding or internal floors and require full adhesion using a suitable adhesive.

For walls, additional hidden anchoring is required where installation exceeds the minimum height required by the local council regulation.

The substrate needs to be rigid, flat and free from any dust or contaminants that could affect the adhesive bonding.

To eliminate possible air trapped behind the panels, tap the panel surface moving from the centre towards the edges.

For further technical information, please also refer to:

Everstone Slim Slab Handling and Installation Manual.
Everstone Reduced Thickness Porcelain Specification.

Everstone has taken every care in providing accurate information in this document. Megaslim® technical information may change without notice. For the latest revision, please check on our website at: www.everstone.com.au



PHONE: **1300 918 918**
FAX: **+61 2 9644 3353**
sales@everstone.com.au

SYDNEY

HEAD OFFICE | SHOWROOM | WAREHOUSE

20 PRINCES ROAD EAST
AUBURN NSW 2144
AUSTRALIA

MELBOURNE

OFFICE | SHOWROOM | WAREHOUSE

168 DISCOVERY ROAD
DANDENONG SOUTH VIC 3175
AUSTRALIA

BRISBANE

PHONE: 0418 886 833

